



LIGHTPIECE ANTONIO CITTERIO 2002
SECTIONAL SOFAS

LIGHTPIECE | ANTONIO CITTERIO | 2002

Frame in wood and metal with polyurethane padding covered with a protective fabric lining

Seat cushions in sterilized goose down (Assopiuma certified, gold label) with insert in crushproof material; or, in polyurethane foam and dacron

Backrest cushions in sterilized goose down (Assopiuma certified, gold label) available with or without support bolster padded with polyurethane foam. Optional backrest cushions are upon request, with upcharge

Metal armrest-shelf

Outer frame in steel or covered in hide leather: russian red 5008, olive 5006, black 5005, dark brown 5004, dark brown extra 5013, grey 5003, sand 5001, tobacco 5015. Also available in black suede 6005, dark brown suede 6004, olive suede 6003, sand suede 6001

Inner frame in metal coated with epoxy powder: white 100, pearl beige 130, cream

white 150, white mat 160, cream colour 205, wine red 405, kaki green 705, umbra grey 720, pearl mouse grey 740, brown grey 805, black 900

Leather armrest-shelf

Frame in metal covered in hide leather: russian red 5008, olive 5006, black 5005, dark brown 5004, dark brown extra 5013, grey 5003, sand 5001, tobacco 5015. Also available in black suede 6005, dark brown suede 6004, olive suede 6003, sand suede 6001

Fabric armrest

Frame in wood and polyurethane padding covered with a protective fabric lining

Feet made of glossy transparent methacrylate

Upholstery is removable in both the fabric and leather versions

COD. 011P01

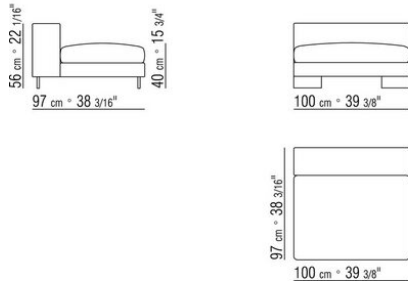

COD. 011P02

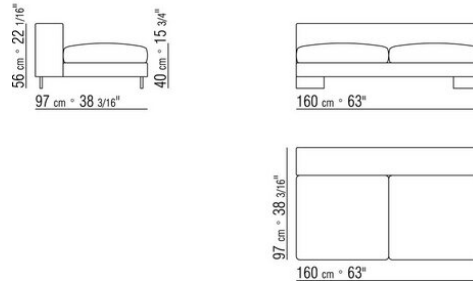

COD. 011P03

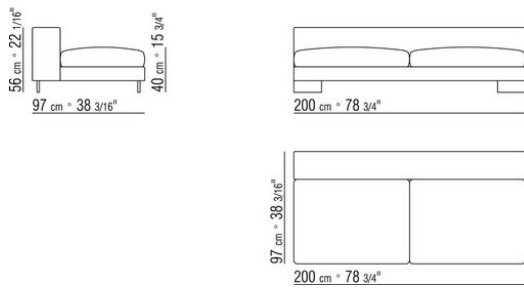

COD. 011P04

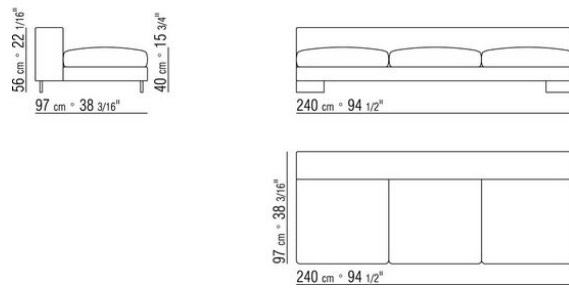

COD. 011P05

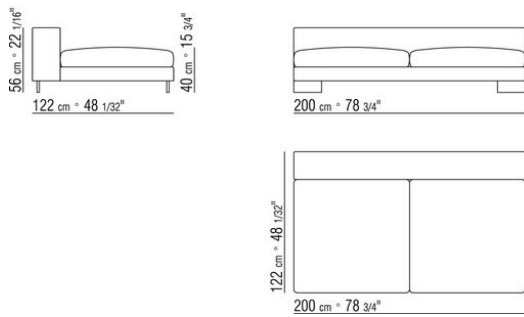

COD. 011P06

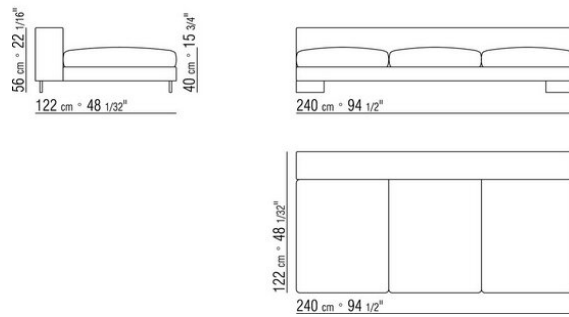

COD. 011P11

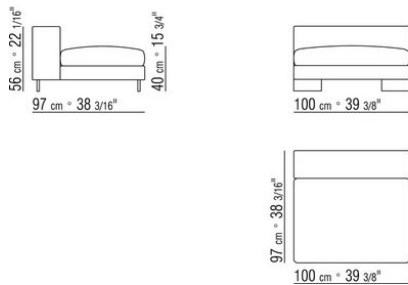

COD. 011P12

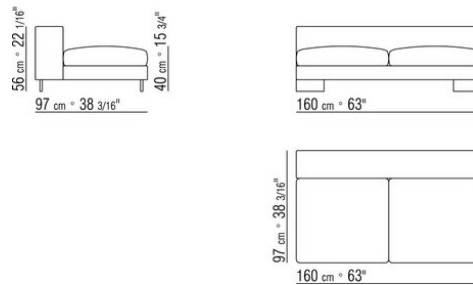

TECHNICAL DRAWINGS | LIGHTPIECE

COD. 011P13

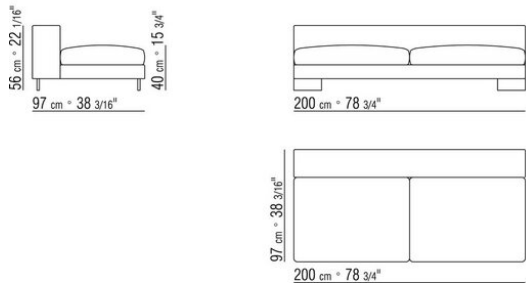

COD. 011P14

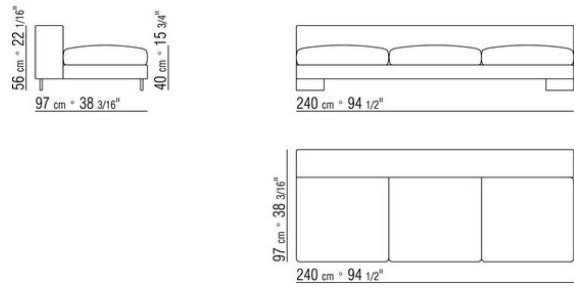

COD. 011P15

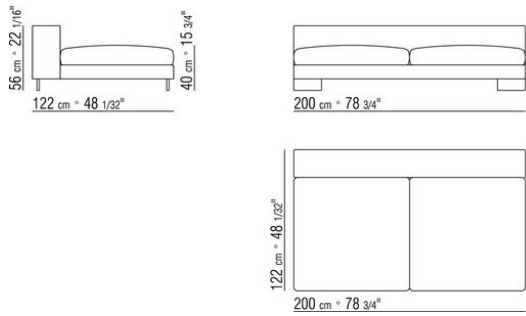

COD. 011P16

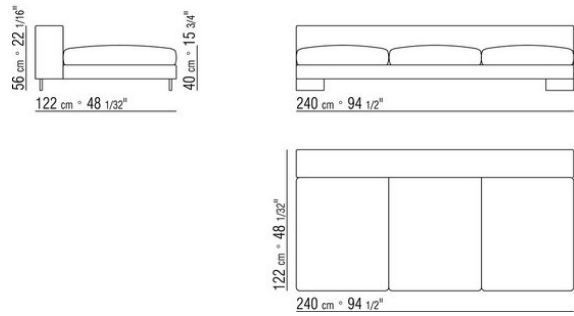

COD. 011P70

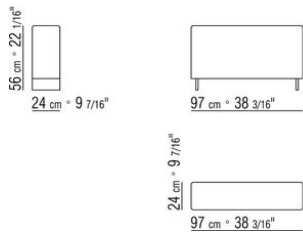

COD. 011P71

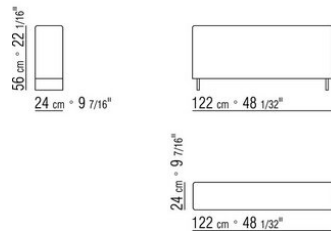

COD. 011P72

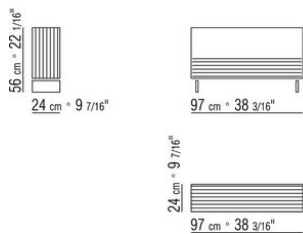

COD. 011P73

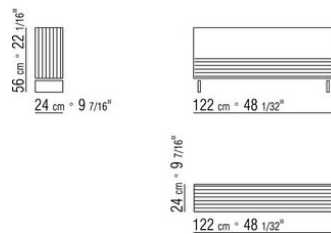

TECHNICAL DRAWINGS | LIGHTPIECE

COD. 011P76

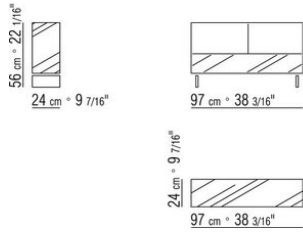

COD. 011P77

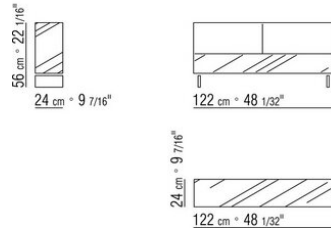

COD. 011P93

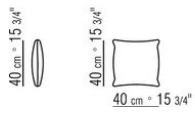

COD. 011P92

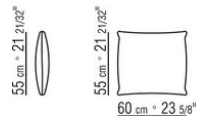

COD. 011P99

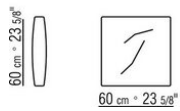

COD. 011P95

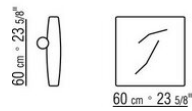

COD. 011P94

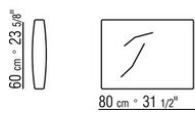

COD. 011P97

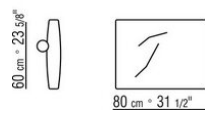

COD. 011P98

COD. 011P96

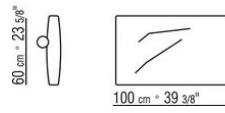
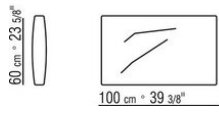

COD. 011P50

COD. 011P51

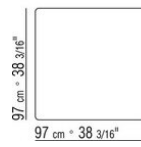
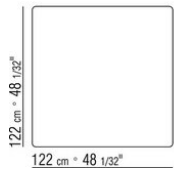
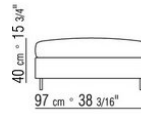
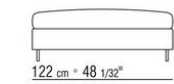

COD. 011P52

COD. 011P56

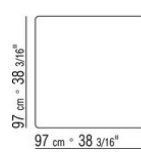
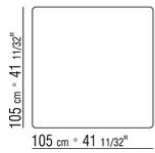
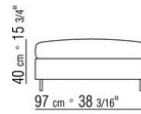
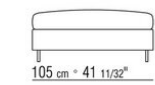

COD. 011P57

COD. 011P55

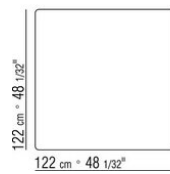
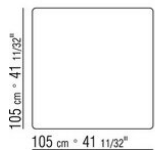
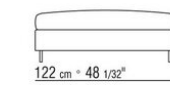
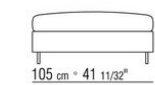

011PXA

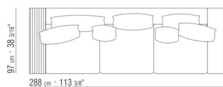

- N.1 COD.011P72 - ARMREST HIDE LEATHER CM.97 x24
- N.1 COD.011P70 - ARMREST CM.97 x24
- N.1 COD.011P04 - UNIT CM.240 x97
- N.1 COD.011P99 - CUSHION CM.60 x60
- N.2 COD.011P95 - CUSHION WITH ROLL CM.60 x60
- N.1 COD.011P97 - CUSHION WITH ROLL CM.80 x60
- N.2 COD.011P93 - CUSHION CM.40 x40
- N.1 COD.011P92 - CUSHION CM.60 x55

011PXC

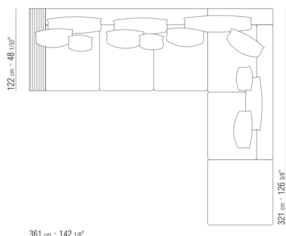

- N.1 COD.011P73 - ARMREST HIDE LEATHER CM.122 x24
- N.1 COD.011P70 - ARMREST CM.97 x24
- N.1 COD.011P06 - UNIT CM.240 x122
- N.1 COD.011P03 - UNIT CM.200 x97
- N.1 COD.011P51 - OTTOMAN CM.97 x97
- N.2 COD.011P99 - CUSHION CM.60 x60
- N.3 COD.011P97 - CUSHION WITH ROLL CM.80 x60
- N.1 COD.011P96 - CUSHION WITH ROLL CM.100 x60
- N.3 COD.011P93 - CUSHION CM.40 x40
- N.3 COD.011P92 - CUSHION CM.60 x55